

Content:

Technical specification and battery	1	Programming Shuttle motor S / M / L	5
Display, unlock and mode setting	2	Programming Shuttle click-on receiver	6
Switching between 15 and 2 channels	3	Programming external receiver	7
Set time and day	3	Programming tubular and BS motor	8
Set automatic timer	4		

TECHNICAL SPECIFICATION:

- 2x Alkaline battery type AAA, LR03
- battery life < 3 years
- frequency 433.92MHz
- transmit power max. 10mW
- transmit range indoor max. 30mtr
- working temperature -10°C - +50°C
- each channel can control up to 20 receivers

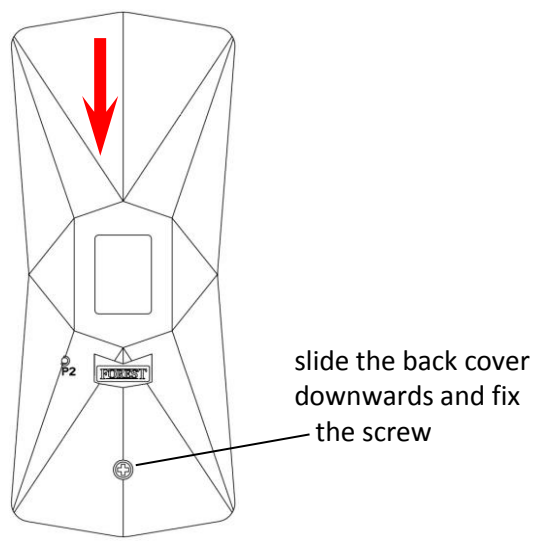
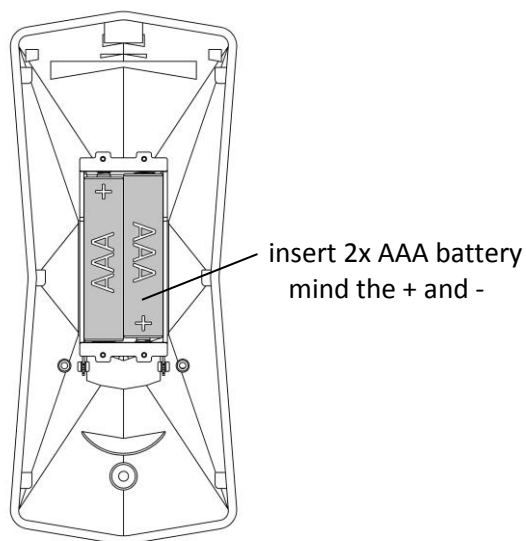
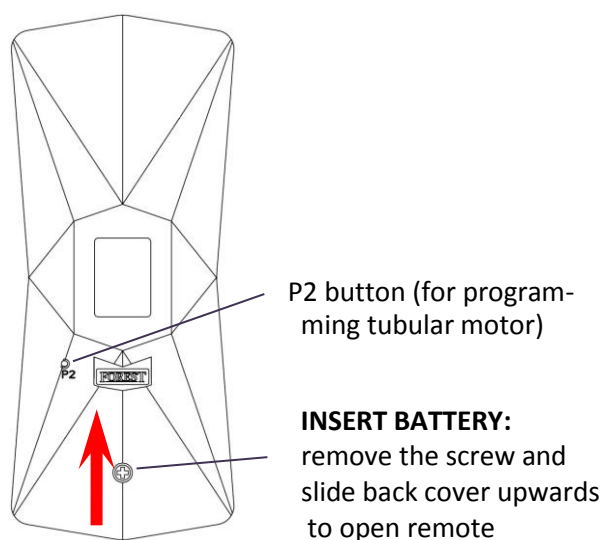
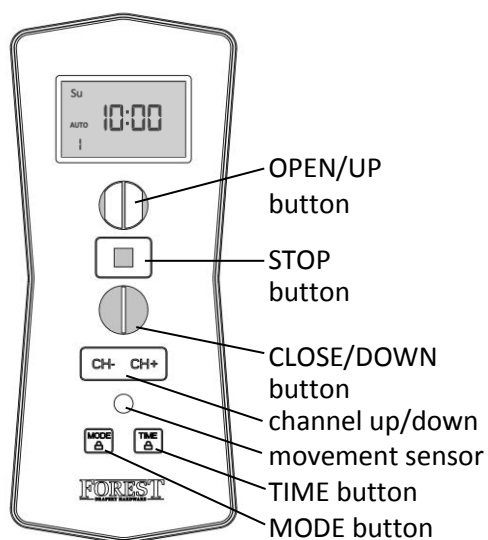

BATTERY EMPTY:

After changing the battery, programmed receivers will stay in memory of Diamond Sense remote. Please follow the local regulations for disposal of the empty battery.

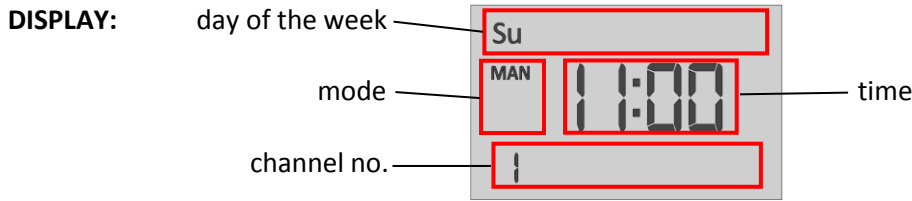

UNLOCK THE MODE AND TIME BUTTONS:

Keep both buttons MODE and TIME pressed for about 4 seconds until the display shows 'LOC'. Now you can set the mode and time.

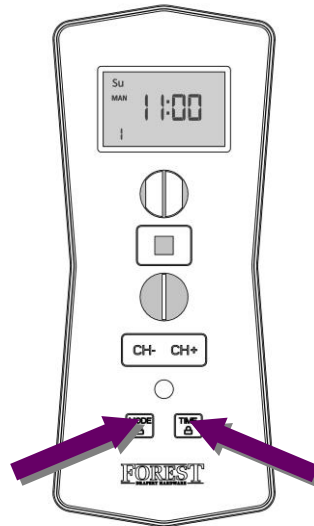

- MODE:**
- MAN ⇔ Manual mode: automatic timer mode is off
 - AUTO ⇔ Auto mode: automatic timer mode is on
 - AUTO ⇔ Random mode: automatic timer mode is on, OPEN and CLOSE time will vary between + and – 15 minutes

To change the mode, keep 'MODE' pressed until the desired mode appears in the display:

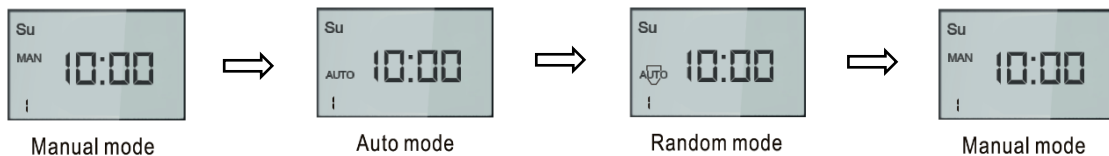

SWITCHING BETWEEN 15 AND 2 CHANNELS:

Default setting of the Diamond Sense is 15 channels. Channel 1 up to 15 can be used.

When desired, for example when you only have one or two motorized systems, you can change the setting to 2 channels:

Keep both buttons, CH- and CH+ pressed for about 8 sec until the display shows F-02.

Now the Diamond Sense is a 2-channel remote control.

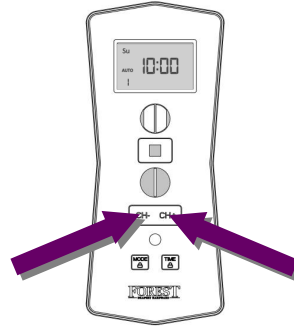

To change back to a 15-channel remote control:

Keep both buttons, CH- and CH+ pressed for about 8 sec until the display shows F-15. Now the Diamond Sense is a 15-channel remote control.

SET CURRENT TIME AND DAY (first unlock the buttons: press and hold MODE and TIME):



MODE must be 'MAN'

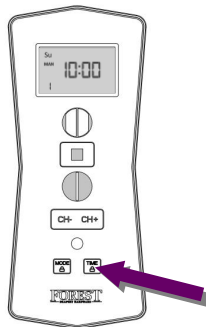

press TIME button once, hours start blinking

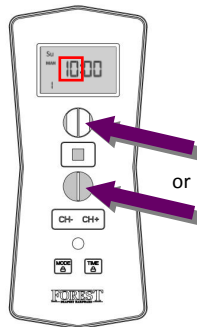

change hours by pressing OPEN or CLOSE button

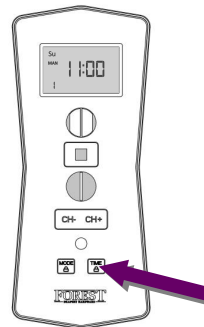

press TIME button once, minutes start blinking

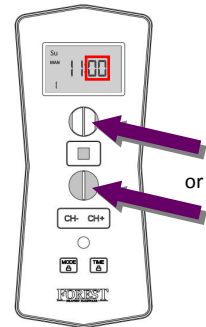

change minutes by pressing OPEN or CLOSE button

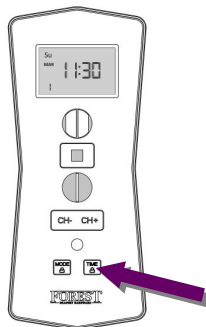

press TIME button once, day starts blinking

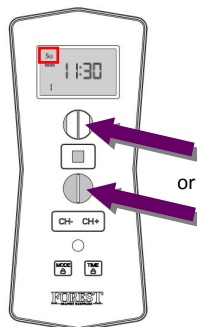

change day by pressing OPEN or CLOSE button

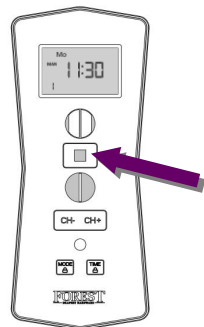

press STOP button to finish

SET AUTOMATIC OPEN AND CLOSE TIME (first unlock the buttons: press and hold MODE and TIME):

In total up to 9 OPEN and 9 CLOSE timing positions can be set. For example use 4 points:

Position 1: Ma-Tu-We-Th-Fr ⇒ 7:30 OPEN

Position 2: Ma-Tu-We-Th-Fr ⇒ 21:00 CLOSE

Position 3: Sa-Su ⇒ 7:00 OPEN

Position 4: Sa-Su ⇒ 20:00 CLOSE

SET TIMING POSITION 1 – OPEN:

MODE must be 'AUTO' or 'AUTO' (press and hold MODE button)

press MODE button once

select the desired channel

press TIME button once, hours start blinking

change hours by pressing OPEN or CLOSE button

press TIME button once, minutes starts blinking

change minutes by pressing OPEN or CLOSE button

press TIME button one, day starts blinking

change day(s) by pressing OPEN or CLOSE button

press STOP button to finish

SET TIMING POSITION 1 – CLOSE:

Repeat steps here above, only start by pressing MODE button twice

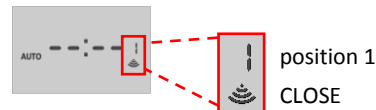

NEXT TIMING POINTS:

can be set in the same way, press multiple times the MODE button until desired timing position OPEN or CLOSE is reached. Maximum of 9 OPEN and 9 CLOSE positions can be set.

You can recognize these Shuttle motors by the white antenna cable.
 To program a Diamond Sense to a Shuttle S / L / M Receiver, first select the desired channel and proceed:

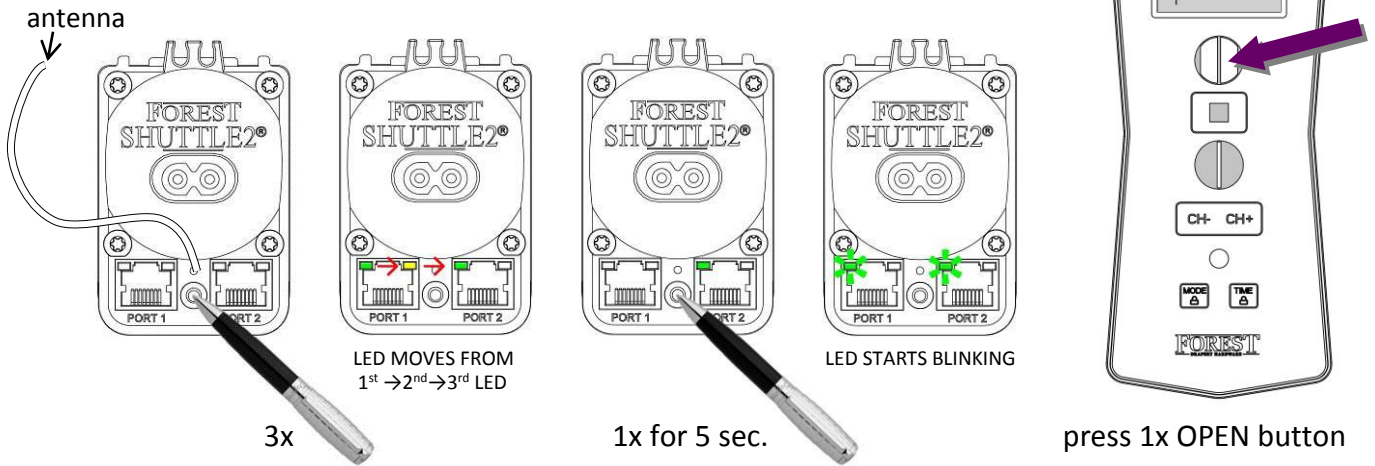

Same procedure, but press CLOSE instead of OPEN, will erase the programmed channel.



Do not mount the motor within 1 meter from other equipment and receivers.
 This will interfere with the receiver.

TECHNICAL SPECIFICATION:

- powered by Shuttle M
- connect to port 1 of the Forest Shuttle M
- working temperature -10°C - +50°C
- controlled by Forest Multi Remote and Forest Multi Wall Switch RF

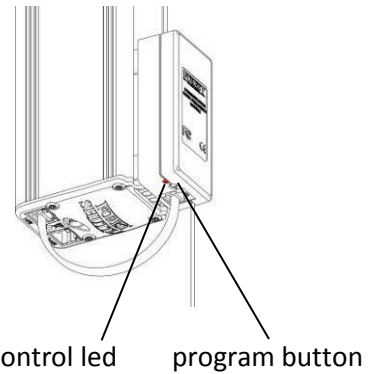

Do not mount within 1 meter from other equipment and receivers.
This will interfere with the receiver.

PROGRAMMING WALL SWITCH TO CLICK-ON RECEIVER:

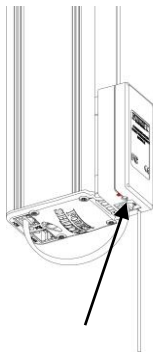

press program button,
led will light up

hold the wall switch within 2 mtr
from receiver. Select channel
and press OPEN button

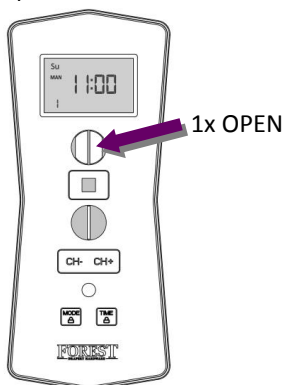

on receiver:
led blinks 3 times and will go off

REMOVE PROGRAMMED CHANNEL:



press program button,
led will light up

select (to be cancelled) channel
and press CLOSE button

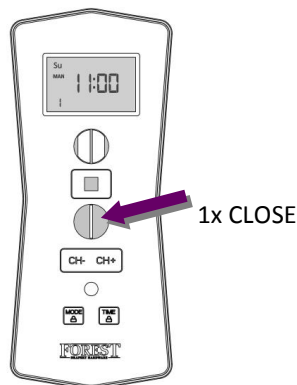

on receiver:
led will blink once and will go off

DELETE ALL PREVIOUS PROGRAMMED CHANNELS:

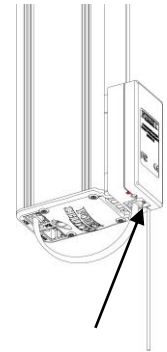

press and hold the program
button for 10 seconds until
control led starts blinking

TECHNICAL SPECIFICATION FMS/BCS RECEIVER:

- power: 100 - 240Vac 50/60Hz – 500Wmax.
- controls one tubular or FMS motor. When more motors → use group relay
- can also be used as wall switch
- terminal max. 2,5mm²
- working temperature -10°C - +50°C

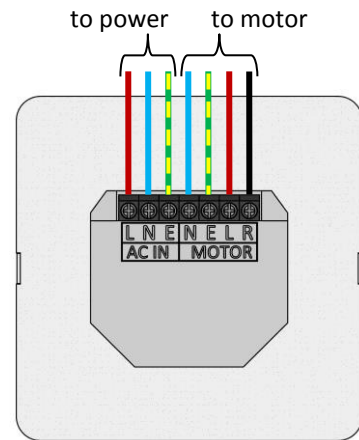
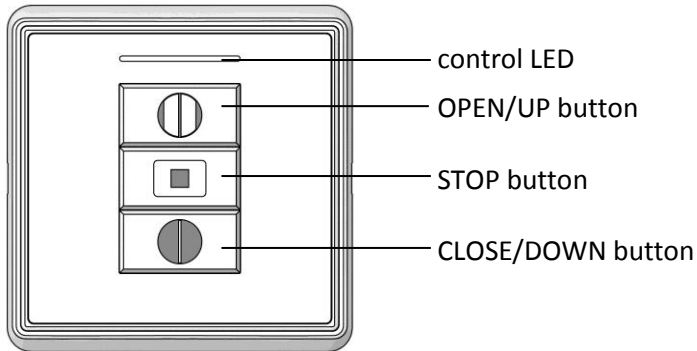

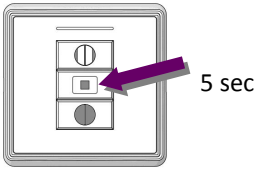
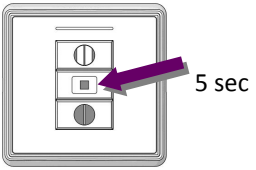
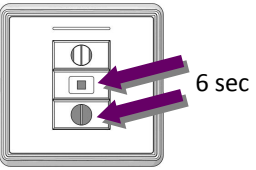
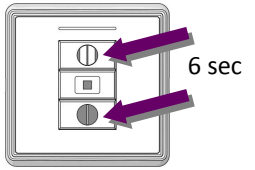
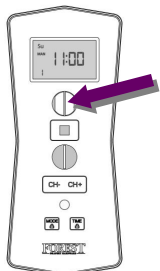
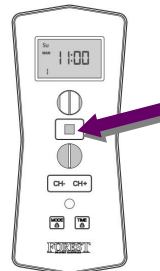
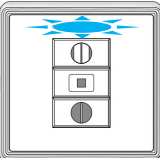
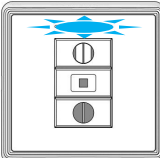
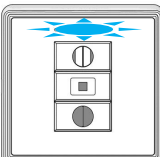
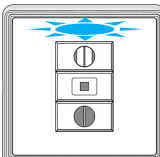
PROGRAMMING CHANNEL TO RECEIVER:	REMOVE PROGRAMMED CHANNEL:	DELETE ALL PREVIOUS PROGRAMMED CHANNELS:	CHANGE MOTOR DIRECTION
<p>keep STOP button pressed for 5 seconds until LED blinks</p>  <p>5 sec</p>	<p>keep STOP button pressed for 5 seconds until LED blinks</p>  <p>5 sec</p>	<p>keep STOP and CLOSE button pressed for 6 seconds</p>  <p>6 sec</p>	<p>keep OPEN and CLOSE button pressed for 6 seconds</p>  <p>6 sec</p>
<p>within 10 sec. select channel and press OPEN button:</p> 	<p>within 10 sec. select (to be removed) channel and press STOP button:</p> 	<p>after 5 sec. the blue LED will blink 3x to acknowledge:</p> 	<p>blue LED will blink 3x to acknowledge:</p> 
<p>blue LED will blink 3x to acknowledge:</p> 	<p>blue LED will blink 3x to acknowledge:</p> 		



Do not mount within 1 meter from other equipment and receivers. This will interfere with the receiver.

PROGRAMMING REMOTE TO TUBULAR MOTOR:

press button on motor, motor will turn short to acknowledge

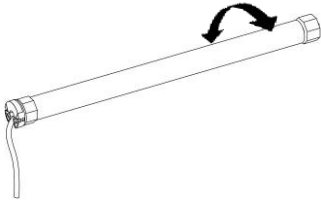

within 6 seconds:

press P button two times

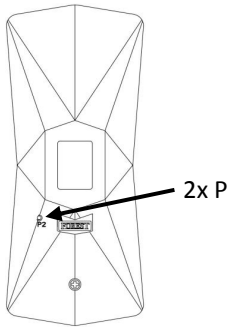

press OPEN button one time

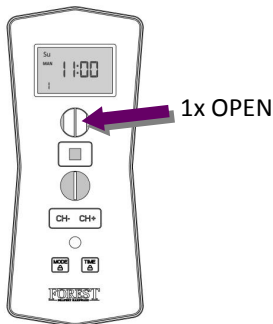

motor will turn to acknowledge

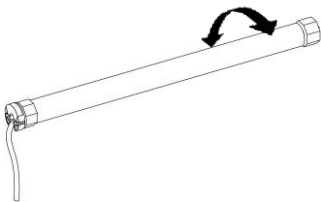

CHANGING DIRECTION OF ROTATION:

To change the direction of rotation, keep green button on motor pressed for 7 sec, until motor turns to acknowledge.

ADD MORE REMOTES OR CHANNELS TO TUBULAR MOTOR

①st remote: press P button two times

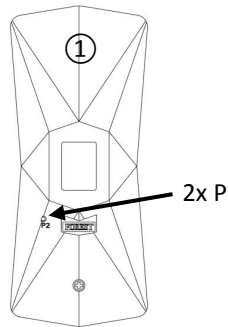

②nd remote: press P button one time

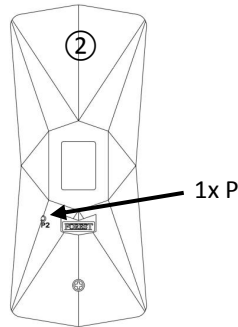

motor will turn to acknowledge

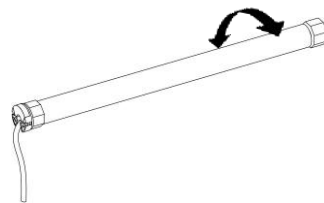

to add another channel:
1.press 2xP button of programmed channel,
2.select other channel and press P button

motor will turn to acknowledge

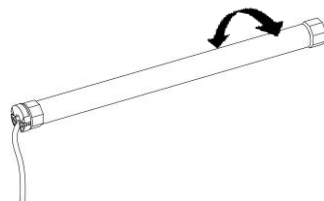

CANCEL ALL REMOTES

press P button one time

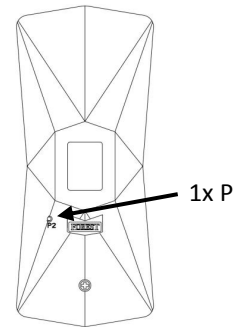

press STOP button one time

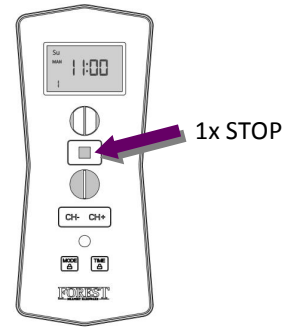

press P button one time

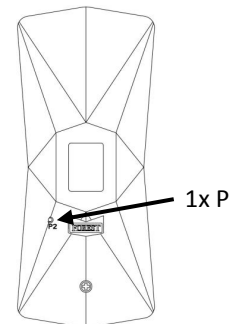

motor will turn to acknowledge

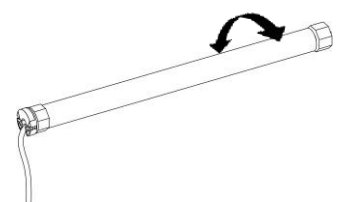

Please check the motor manual for setting the end limits